

(4N29(Short))

AC LINE / DIGITAL LOGIC ISOLATOR.
DIGITAL LOGIC/DIGITAL LOGIC ISOLATOR.
TELEPHONE LINE RECEIVER.
TWISTED PAIR LINE RECEIVER.
RELAY CONTACT MONITOR.

The TOSHIBA 4N29 (Short) through 4N33 (Short) consists arsenide infrared emitting diode coupled with a silicon photo darlington in a dual in-line package.

- Switching Time : 100 μ s (Max.)
- DC Current Transfer Ratio : 500%
- Isolation Resistance : 10¹¹ Ω (Typ.)
- Isolation Voltage : 2500Vrms (Min.)
- UL Recognized : UL1577, File No. E67349

Unit in mm

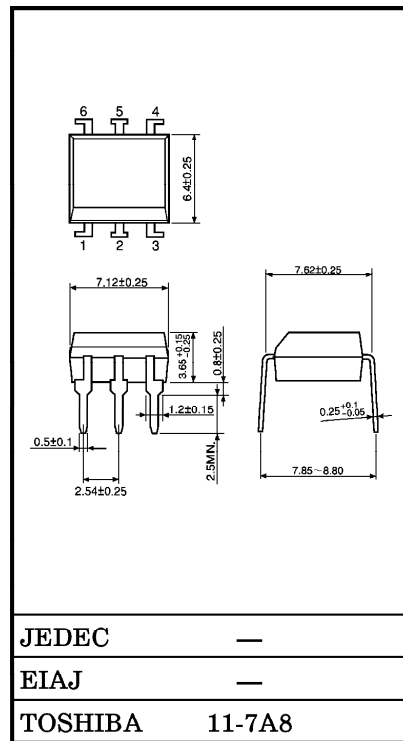

PIN CONFIGURATIONS (TOP VIEW)

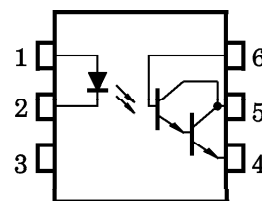

- 1 : ANODE
- 2 : CATHODE
- 3 : N.C.
- 4 : EMITTER
- 5 : COLLECTOR
- 6 : BASE

© The information contained herein is presented only as a guide for the applications of our products. No responsibility is assumed by TOSHIBA CORPORATION for any infringements of intellectual property or other rights of the third parties which may result from its use. No license is granted by implication or otherwise under any intellectual property or other rights of TOSHIBA CORPORATION or others.

© These TOSHIBA products are intended for use in general commercial applications (office equipment, communication equipment, measuring equipment, domestic appliances, etc.). please make sure that you consult with us before you use these TOSHIBA products in equipment which requires extraordinarily high quality and/or reliability, and in equipment which may involve life threatening or critical application, including but not limited to such uses as atomic energy control, airplane or spaceship instrumentation, traffic signals, medical instrumentation, combustion control, all types of safety devices, etc. TOSHIBA cannot accept and hereby disclaims liability for any damage which may occur in case the TOSHIBA products are used in such equipment or applications without prior consultation with TOSHIBA.

①

4N29(Short) - 1

1996 - 4 - 8

TOSHIBA CORPORATION

(4N29(Short))

MAXIMUM RATINGS (Ta = 25°C)

CHARACTERISTIC		SYMBOL	RATING	UNIT
LED	Forward Current (Continuous)	I_F	80	mA
	Forward Current Derating	$\Delta I_F / ^\circ\text{C}$	1.07*	mA / °C
	Peak Forward Current (Note)	I_{PF}	3	A
	Power Dissipation	P_D	150	mW
	Power Dissipation Derating	$\Delta P_D / ^\circ\text{C}$	2.0*	mW / °C
	Reverse Voltage	V_R	3	V
DETECTOR	Collector-Emitter Voltage	BV_{CEO}	30	V
	Collector-Base Voltage	BV_{CBO}	30	V
	Emitter-Collector Voltage	BV_{ECO}	5	V
	Collector Current (Continuous)	I_C	100	mA
	Power Dissipation	P_C	150	mW
	Power Dissipation Derating	$\Delta P_C / ^\circ\text{C}$	2.0*	mW / °C
COUPLED	Storage Temperature Range	T_{stg}	-55~150	°C
	Operating Temperature Range	T_{opr}	-55~100	°C
	Lead Soldering Temperature	T_{sol}	260	°C
	Total Package Power Dissipation	P_T	250	mW
	Total Package Power Dissipation Derating	$\Delta P_T / ^\circ\text{C}$	3.3*	mW / °C

Note : Pulse width 300 μ s, 2% duty cycle.

* Above 25°C ambient.

(4N29(Short))

ELECTRICAL CHARACTERISTICS (Ta = 25°C)

CHARACTERISTIC		SYMBOL	TEST CONDITION	MIN.	TYP.	MAX.	UNIT	
LED	Forward Voltage	V_F	$I_F = 10\text{mA}$	—	1.15	1.5	V	
	Reverse Current	I_R	$V_R = 3\text{V}$	—	—	100	μA	
	Capacitance	C_D	$V = 0, f = 1\text{MHz}$	—	30	—	pF	
DETECTOR	DC Forward Current Gain	h_{FE}	$V_{CE} = 5, I_C = 0.5\text{mA}$	—	10K	—	—	
	Collector-Emitter Breakdown Voltage	$V_{(BR)CEO}$	$I_C = 1\text{mA}$	30	—	—	V	
	Collector-Base Breakdown Voltage	$V_{(BR)CBO}$	$I_C = 100\mu\text{A}$	30	—	—	V	
	Emitter-Collector Breakdown Voltage	$V_{(BR)ECO}$	$I_E = 100\mu\text{A}$	5	—	—	V	
Collector Dark Current		I_{CEO}	$V_{CE} = 10\text{V}$	—	1.0	100	nA	
COUPLED	Collector Output Current	4N32, 4N32A, 4N33	$I_F = 10\text{mA}, V_{CE} = 10\text{V}$	50	—	—	mA	
		4N29, 4N29A, 4N30		10	—	—		
		4N31		5	—	—		
	Collector-Emitter Saturation Voltage	4N29, 4N29A, 4N30, 4N32, 4N32A, 4N33	$V_{CE(sat)}$	$I_F = 8\text{mA}, I_C = 2\text{mA}$	—	—	1.0	V
		4N31			—	—	1.2	
	Turn-on Time		t_{on}	$I_F = 200\text{mA}, V_{CC} = 10\text{V}$ $I_C = 50\text{mA}$	—	—	5	μs
	Turn-off Time	4N29, 4N29A, 4N30, 4N31	t_{off}		—	—	40	μs
		4N32, 4N32A, 4N33					100	
	Capacitance Input to Output		C_S	$V = 0, f = 1\text{MHz}$	—	0.8	—	pF
	Isolation Resistance		R_S	$V = 500\text{V}$	—	10^{11}	—	Ω
Isolation Voltage			BV_S	$AC, 1 \text{ Minute R. H.} \leq 60\%$	2500	—	—	Vrms
		4N29, 4N29A, 4N32, 4N32A	BV_S^*	AC, Peak	2500	—	—	Vpk
		4N30, 4N31, 4N33			1500	—	—	
		4N29A, 4N32A		AC, 1 second	1775	—	—	Vrms

* JEDEC registered minimum BV_S , however, Toshiba specifies a minimum BV_S of $2500V_{rms}$ 1 minute.

(4N29(Short))

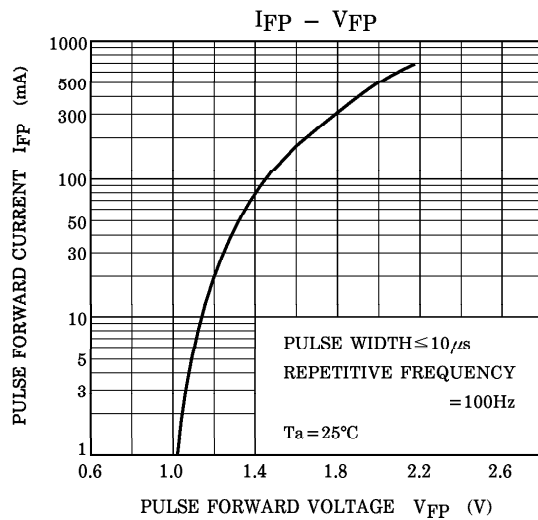
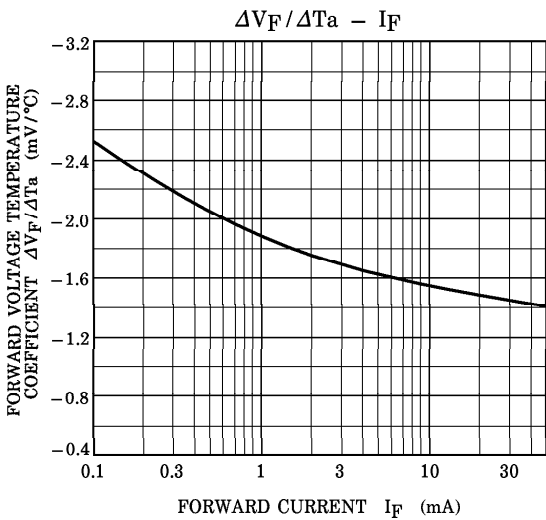
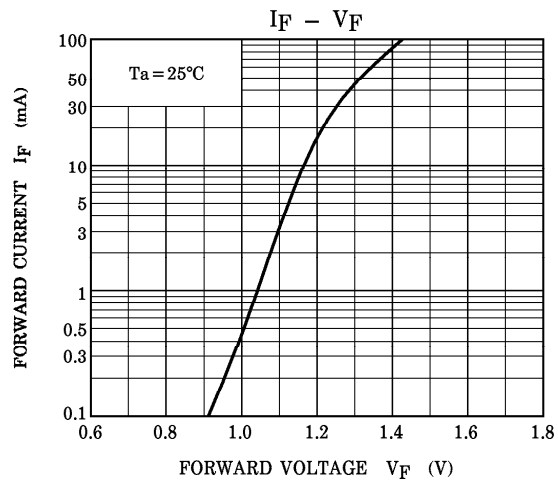
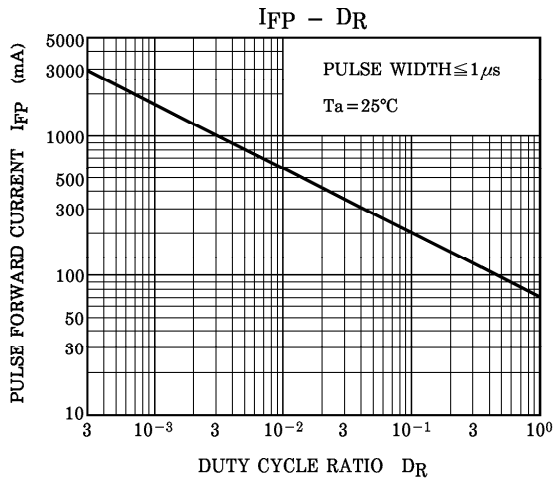
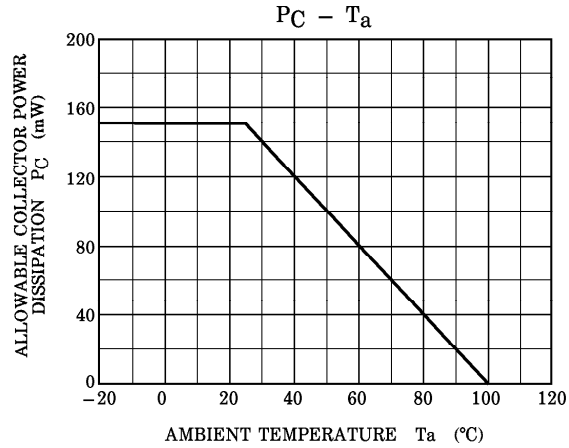
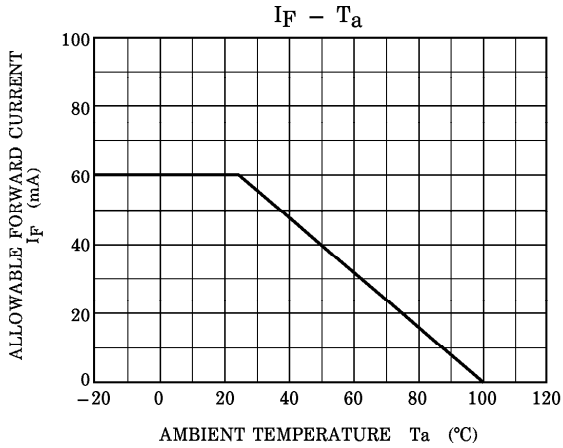

(4N29(Short))

